

COMUNE DI MONTELANICO

REGOLAMENTO EDILIZIO

ALLEGATO "G"
TIPOLOGIE INTERVENTI TIPO
RECUPERO FACCIATE

Allegato 1

Situazione

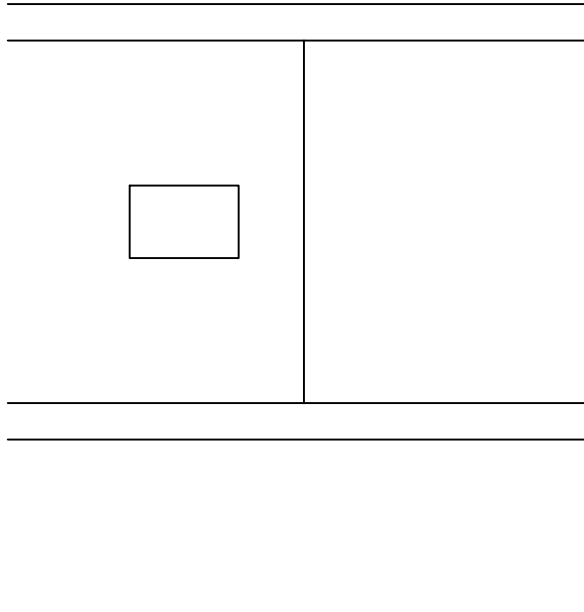

Piano stradale

Soluzione

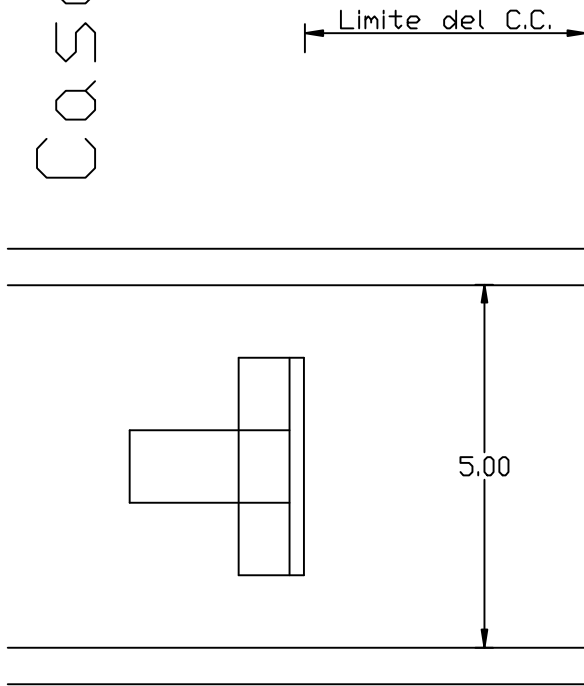

Caso 1

Limite del C.C.

Limite interno
MURO DI CONFINE

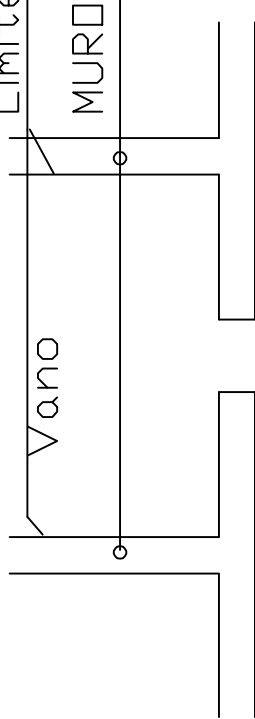

Limite interno
MURO DI CONFINE

Max 1.10
Min 1.00
Min 1.00

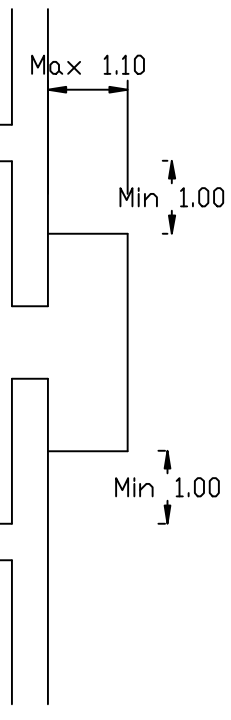

Situazione

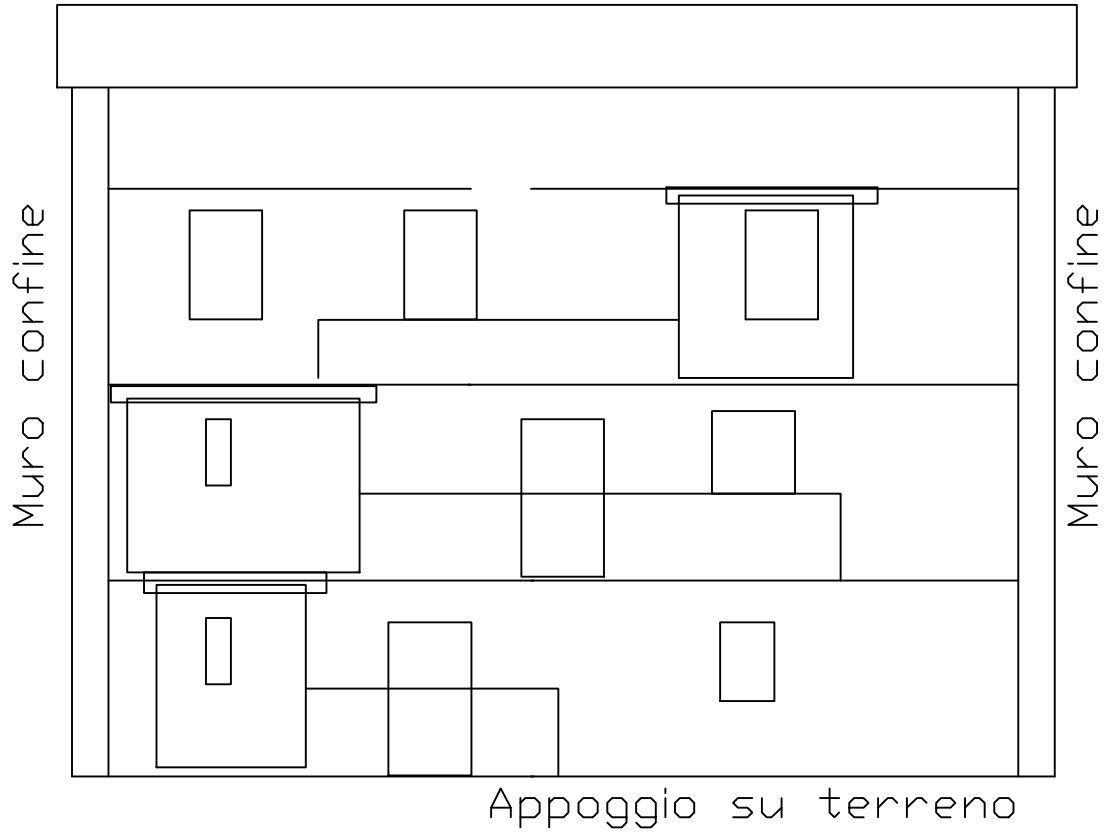

Soluzione tipo

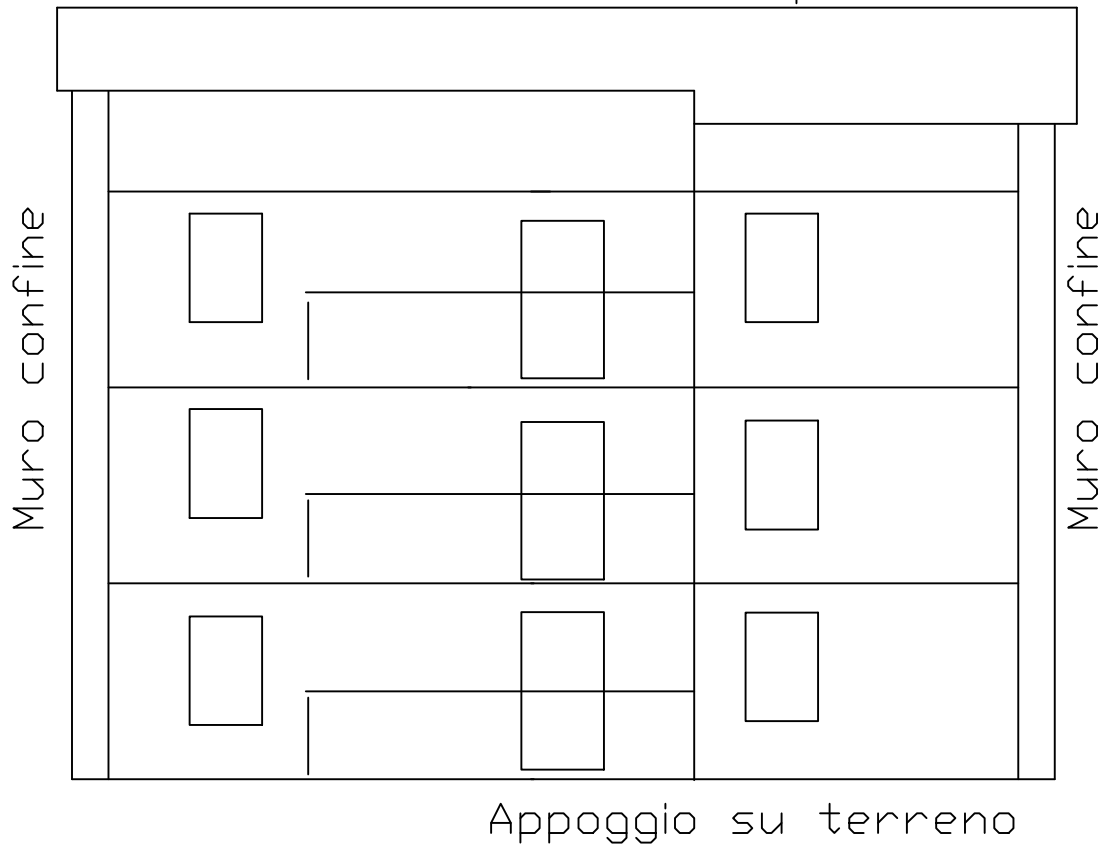

Allegato 2

Caso 2

Situazione

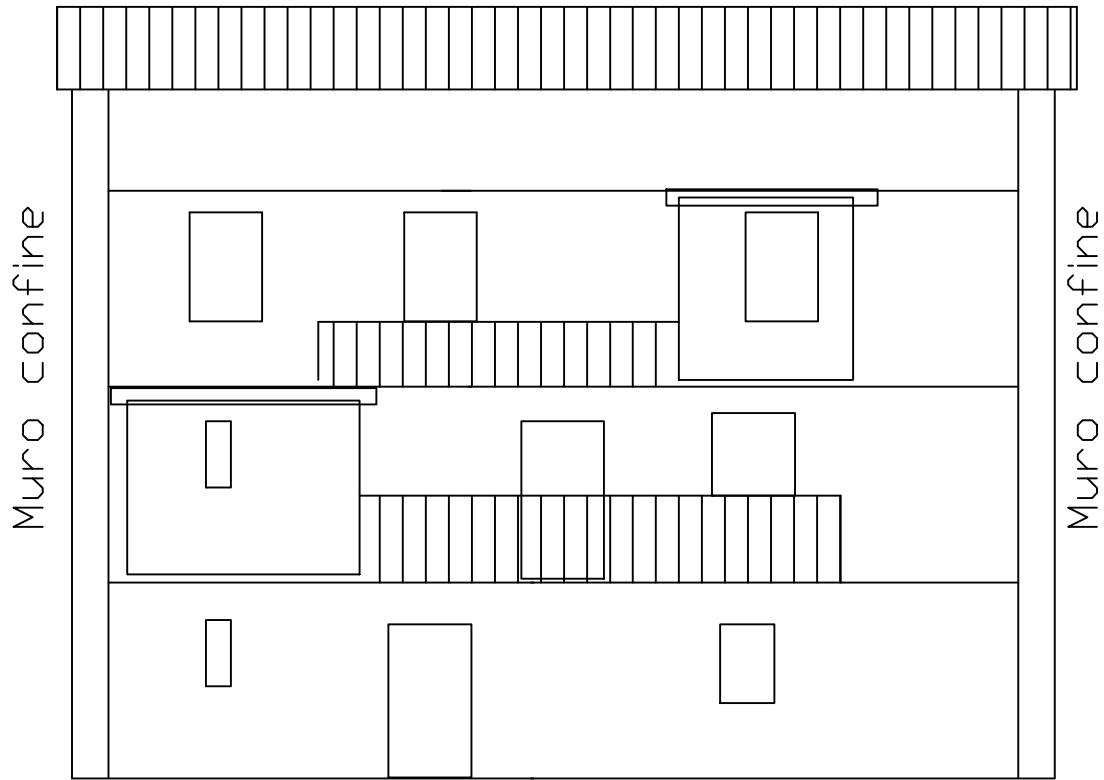

Appoggio su strada

Soluzione tipo

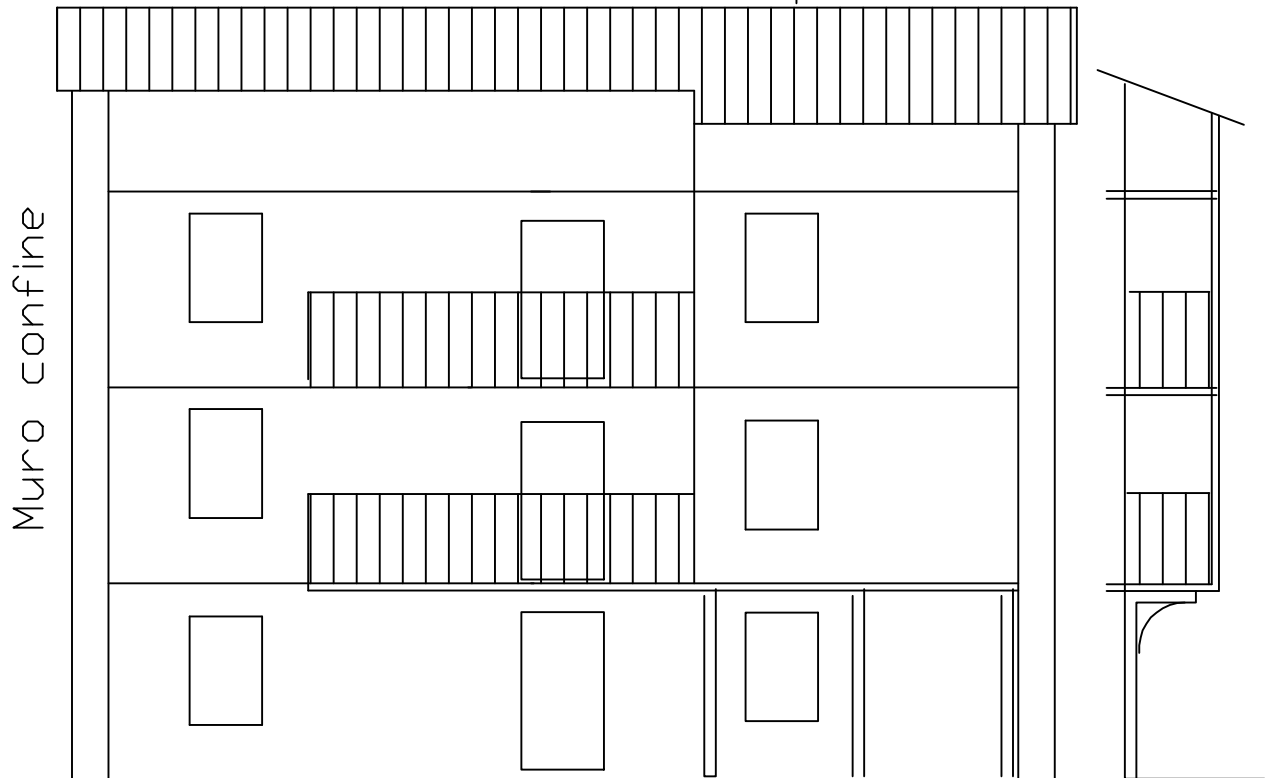

Appoggio su strada

Caso 2

Situazione

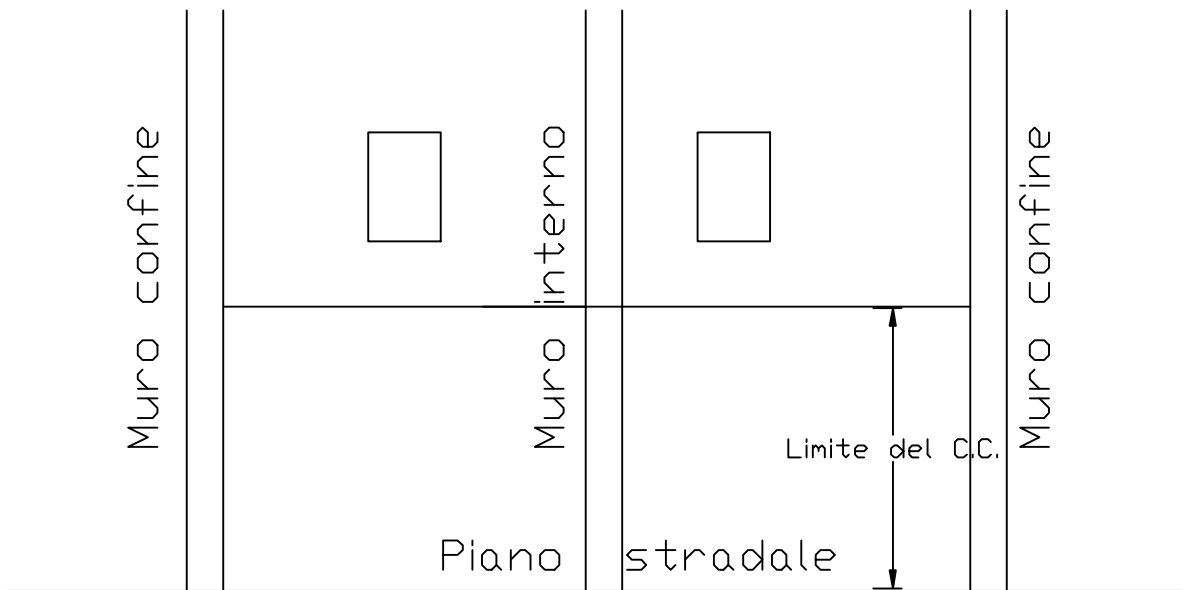

Soluzione 1

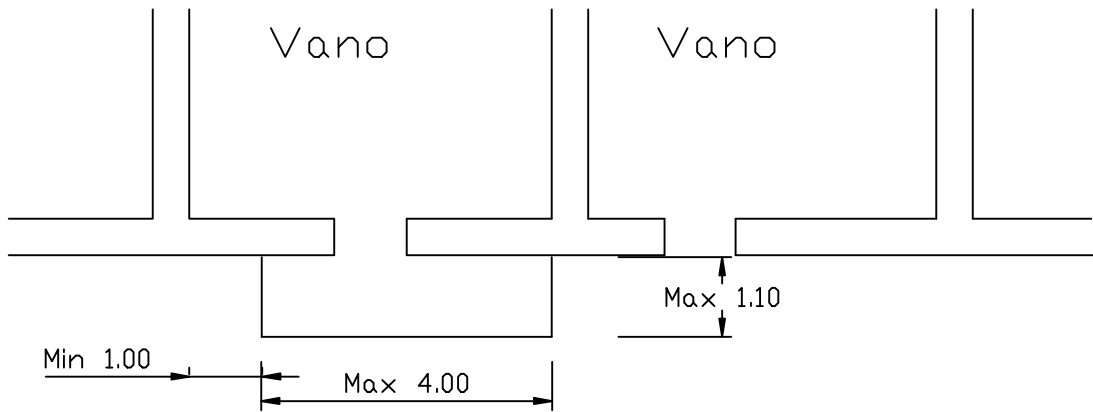

Soluzione 2

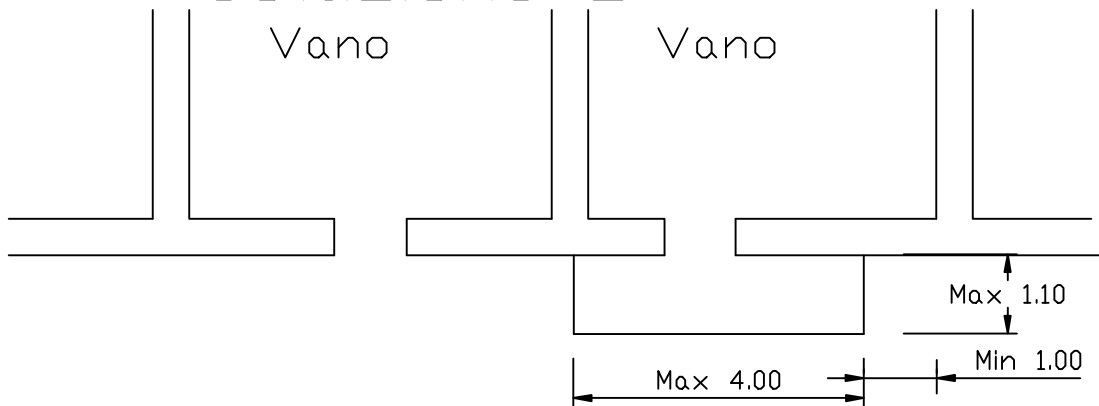

Caso 3

Situazione

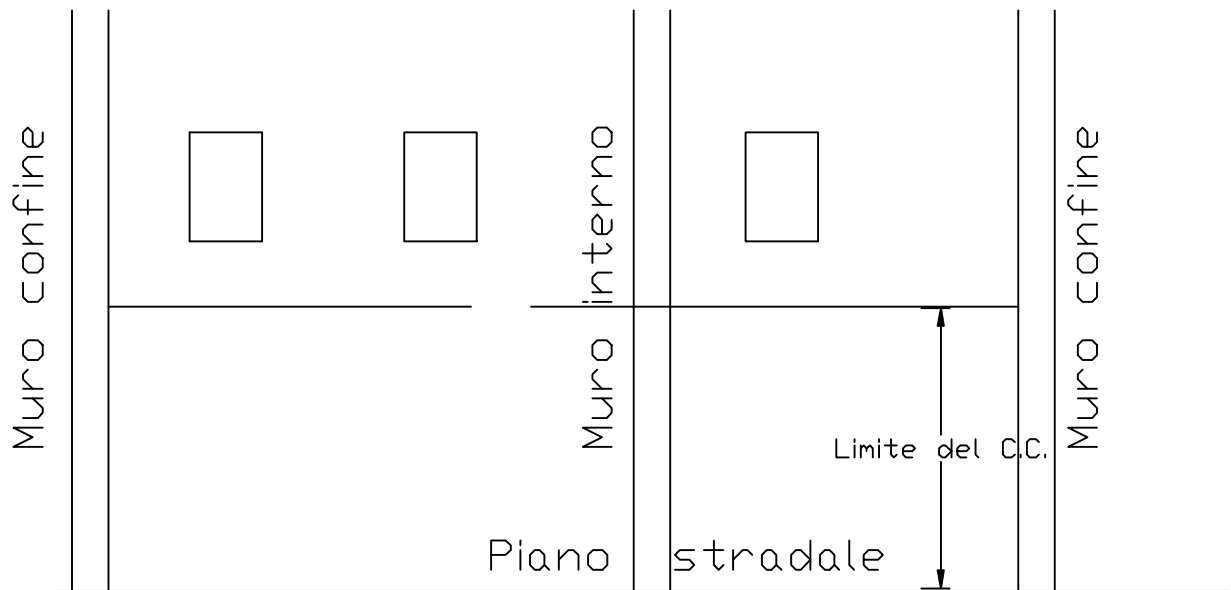

Soluzione 1

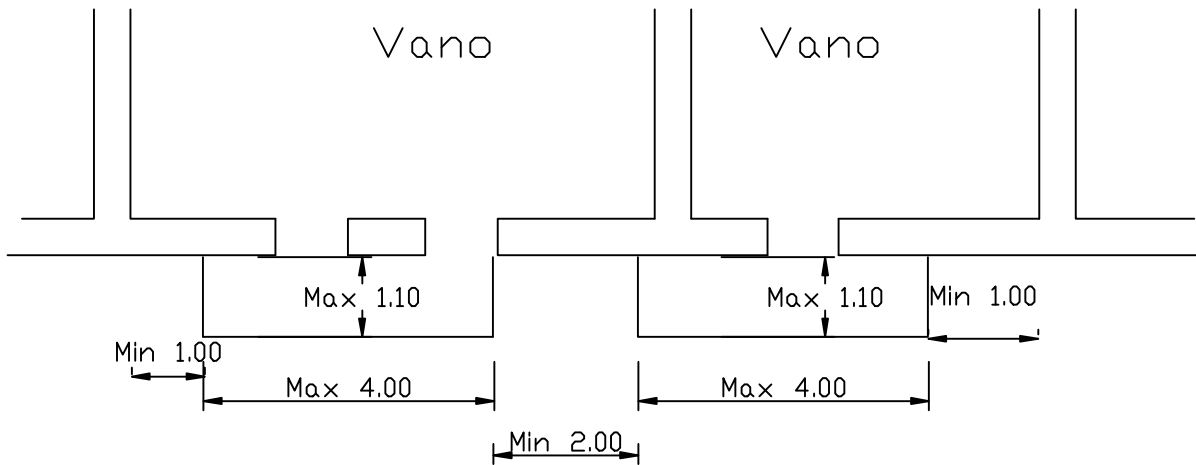

Soluzione 2

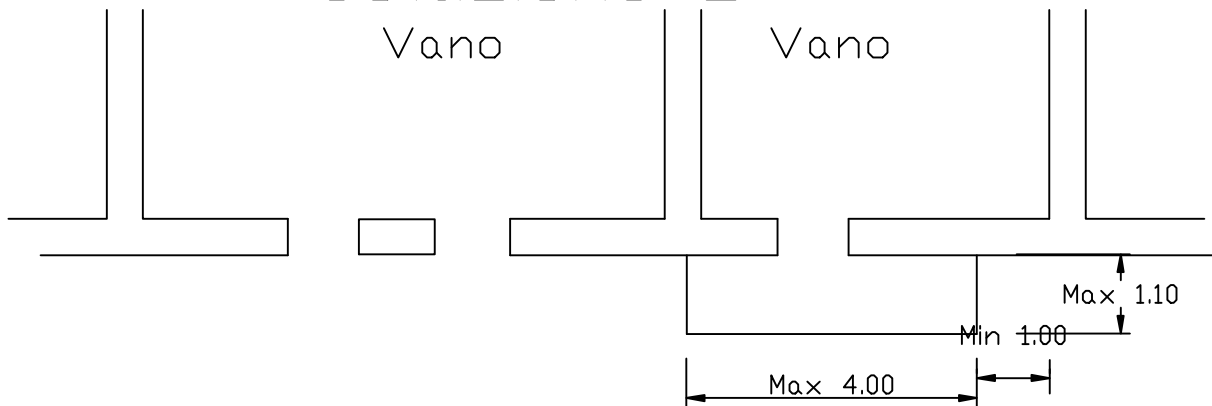

Caso 3

Situazione

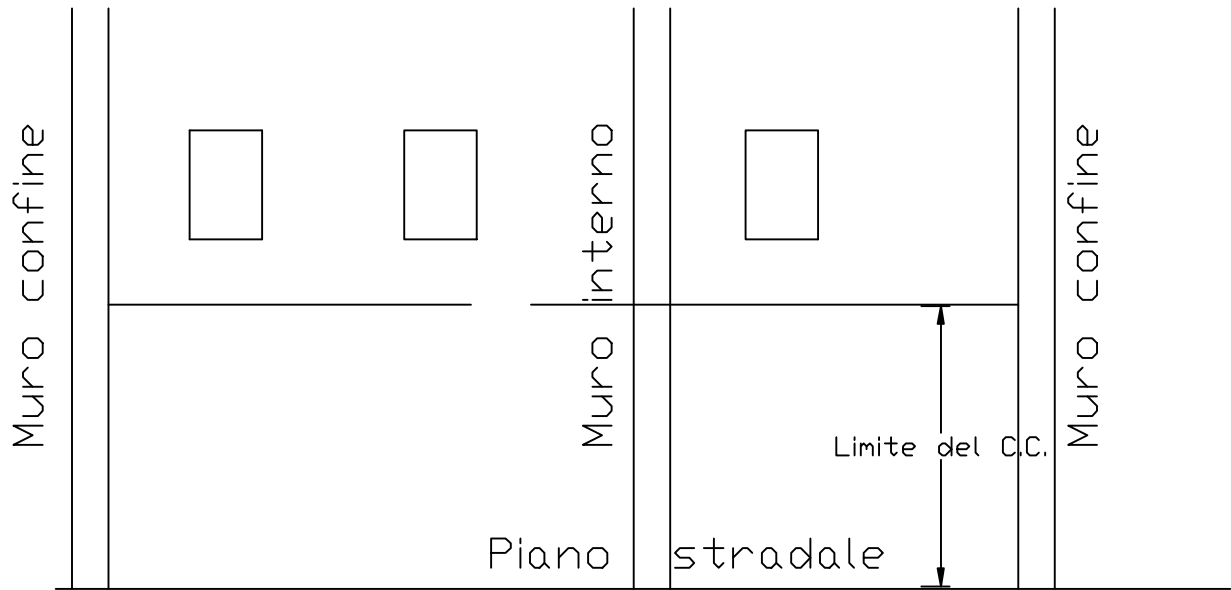

Soluzione 3

